



Architect/Engineering Specifications:

Atmospheric vacuum breaker with polished chrome plated brass body and 1/2" NPT female inlet and outlet. Certified to ASME A112.18.1/CSA B125.1, NSF 61-Section 9, NSF 372 and ASSE 1001.

Job Name _____

Model Specified _____ Quantity _____

Variations Specified _____

Date _____

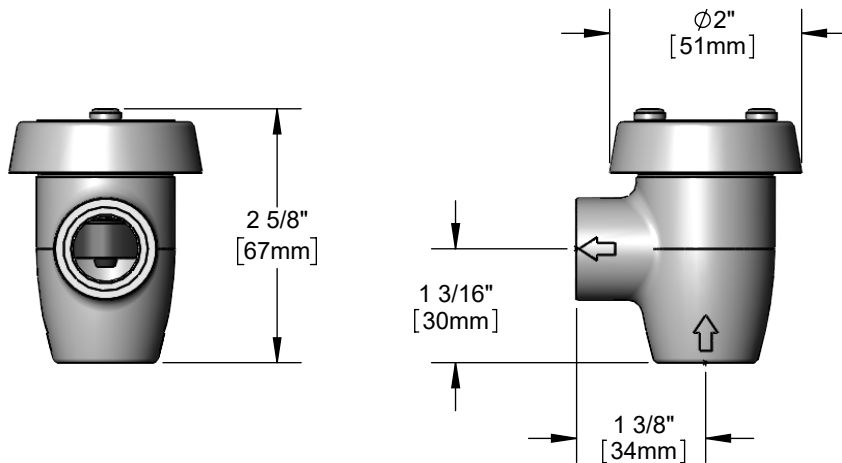

Features & Benefits:

- Atmospheric vacuum breaker
- 1/2" NPT female inlet & outlet
- Material: Polished chrome plated brass body

Product Compliance:

- ASME A112.18.1 / CSA B125.1
- NSF 61 - Section 9
- NSF 372 (Low Lead Content)
- ASSE 1001 (VB)



Warranty: One Year (Limited)

Performance Data:

- Pressure: 20 - 125 psi [1.38 - 8.62 bar]
- Temperature: 40°F - 180°F [4.44°C - 82.22°C]
- Flow Rate: 13.70 GPM [51.86 L/min] @ 60 psi [4.14 bar]

