



T&S BRASS AND BRONZE WORKS, INC.
 2 Saddleback Cove / P.O. Box 1088
 Travelers Rest, SC 29690

Model No.

B-0100-36HF

Item No.

Travelers Rest, SC: 800-476-4103 • Simi Valley, CA: 800-423-0150 • Fax: 864-834-3518 • www.tsbrass.com

This Space for Architect/Engineer Approval

Job Name _____ Date _____

Model Specified _____ Quantity _____

Customer/Wholesaler _____

Contractor _____

Architect/Engineer _____

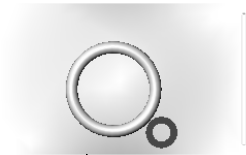

Hold Down Ring w/
Hose Washer

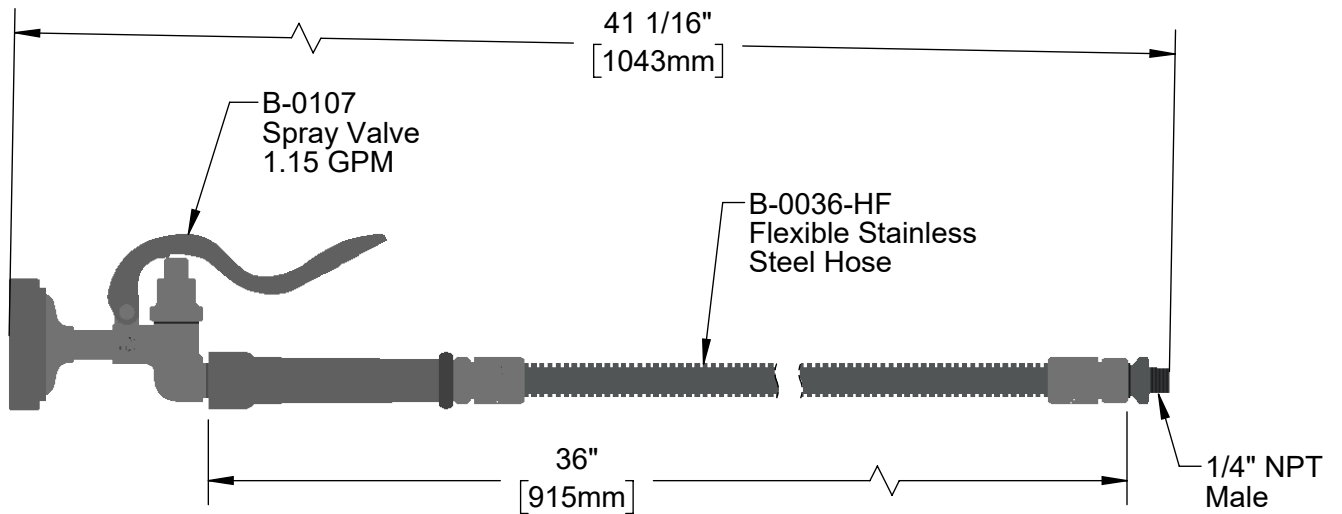

Product Specifications:

Pre-Rinse Unit Accessory:
1.15 GPM Spray Valve w/ 36" Flexible Stainless Steel Hose & Adapter

Product Compliance:

ASME A112.18.1 / CSA B125.1
 NSF 61 - Section 9
 NSF 372 (Low Lead Content)
 2019 DOE PRSV - Class II



T&S BRASS AND BRONZE WORKS, INC.

2 Saddleback Cove / P.O. Box 1088
Travelers Rest, SC 29690

Model No.

B-0100-36HF

Item No.

Travelers Rest, SC: 800-476-4103 • Simi Valley, CA: 800-423-0150 • Fax: 864-834-3518 • www.tsbrass.com

ITEM NO.	SALES NO.	DESCRIPTION
1	B-0107	1.15 GPM Gray Spray Valve
2	010476-45	#27 Washer
3	B-0036-HF	36" Flexible Stainless Steel Hose w/ Fisher Adapter
4	172A	Adapter, 1/4" NPT Male
5	000907-45	Spray Valve Hold Down Ring

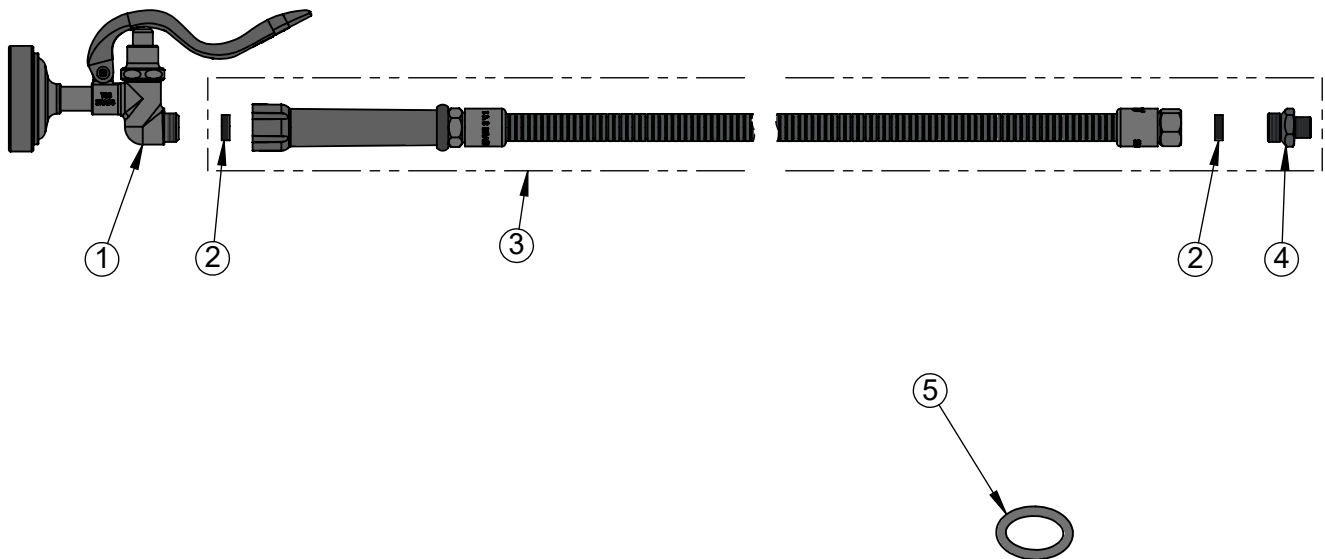

Product Specifications:
Pre-Rinse Unit Accessory:
1.15 GPM Spray Valve w/ 36" Flexible Stainless Steel Hose & Adapter

Product Compliance:
ASME A112.18.1 / CSA B125.1
NSF 61 - Section 9
NSF 372 (Low Lead Content)
2019 DOE PRSV - Class II