



Swivel Sink and Pantry Faucets

5F-1SLX06

TAG:

Deck Mount Faucet

Architect/Engineering Specifications:

Single hole single temperature deck mount faucet with polished chrome plated brass body, 6 1/8" swing nozzle, laminar flow device, ceramic cartridge, lever handle and 1/2" NPSM male inlet. Certified to ASME A112.18.1/CSA B125.1, NSF 61-Section 9 and NSF 372. Meets ADA ANSINCC A117.1 requirements.

Job Name _____
 Model Specified _____ Quantity _____
 Variations Specified _____
 Date _____

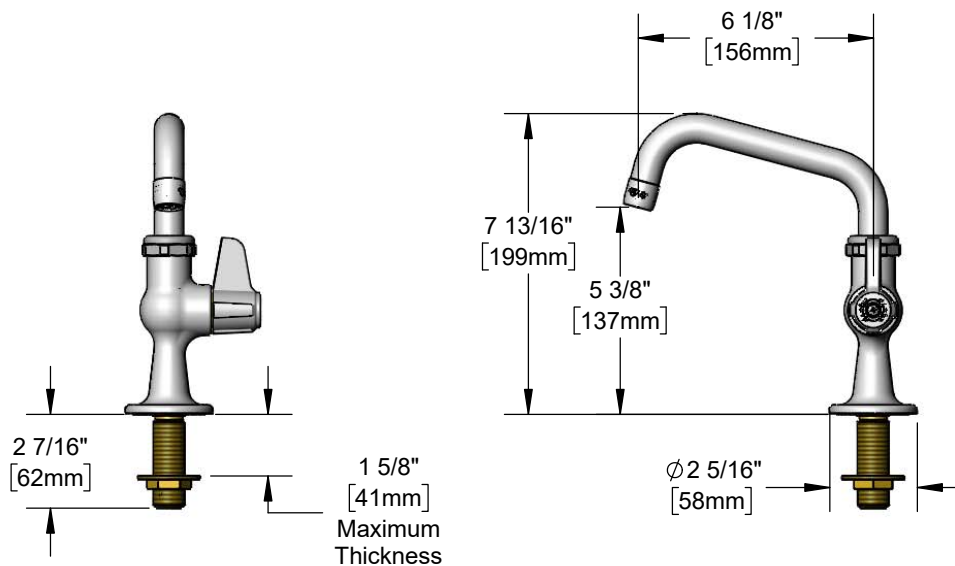

Features & Benefits:

- Single hole single temperature deck mount faucet w/ polished chrome plated brass body
- 6 1/8" swing nozzle w/ laminar flow device
- Quarter-turn ceramic cartridge
- equip lever handle
- 1/2" NPSM male inlet
- Material: Polished chrome plated brass body and chrome plated metal handle

Product Compliance:

- ASME A112.18.1 / CSA B125.1
- NSF 61 - Section 9
- NSF 372 (Low Lead Content)
- ANSI A117.1 (ADA)

Warranty: One Year (Limited)

Performance Data:

- Pressure: 20 - 125 psi [1.38 - 8.62 bar]
- Temperature: 40 °F - 140 °F [4.44 °C - 60 °C]
- Flow Rate: 4.76 GPM [18.02 L/min] @ 60 psi [4.14 bar]



equip Foodservice Accessories



• 2 Saddleback Cove • Travelers Rest, SC 29690
Ph 800-891-4808 • Fax 800-868-0084
www.tsbrass.com

Date: 06/11/21