



Architect/Engineering Specifications:

Chrome plated brass 11 1/2" nozzle with 5/8-27 UN male inlet and outlet. Certified to NSF 61-Section 9 and NSF 372.

Job Name _____

Model Specified _____ Quantity _____

Variations Specified _____

Date _____

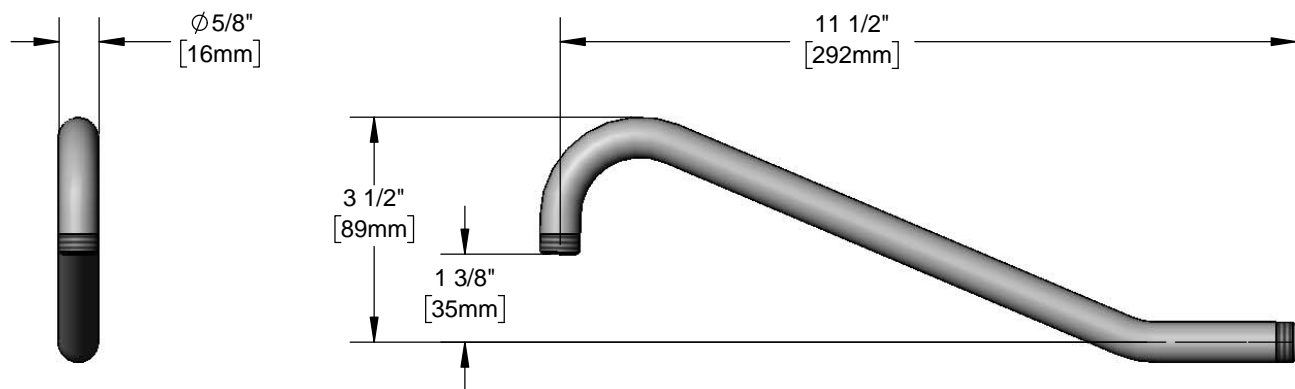
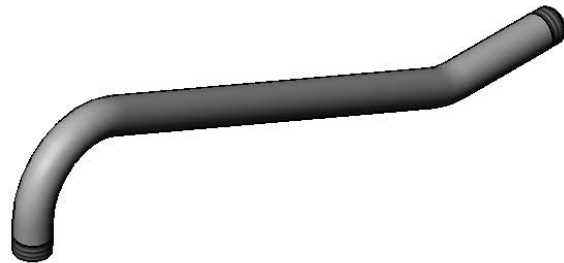

Features & Benefits:

- Chrome plated brass 11 1/2" nozzle
- 5/8-27 UN male inlet and outlet
- Material: Chrome plated brass

Product Compliance:

- NSF 61 - Section 9
- NSF 372 (Low Lead Content)



Warranty: One Year (Limited)

Performance Data:

- N/A

