



Waste Valves
B-3990-BSP-5X

TAG:

Modular Waste Valve

Architect/Engineering Specifications:

Modular push-pull waste valve for 3 1/2" sink opening with stainless steel body, 2" NPT male x 1 1/2" NPT BSP male adapter, push-pull handle with chrome plated metal handle guard, 5" handle extension, 3 1/2" snap-in removable strainer and overflow outlet with cap. Certified to ASME A112.18.2/CSA B125.2

Job Name _____
 Model Specified _____ Quantity _____
 Variations Specified _____
 Date _____

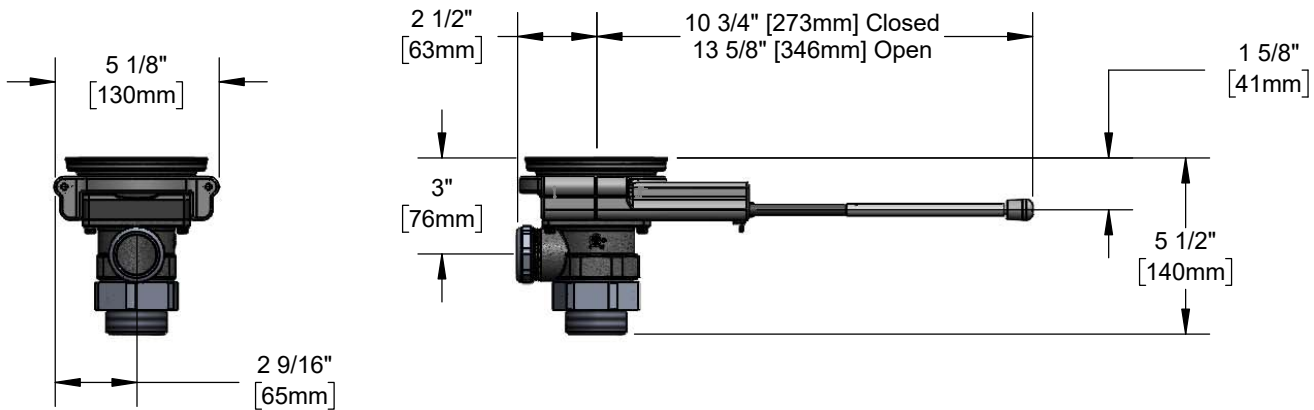
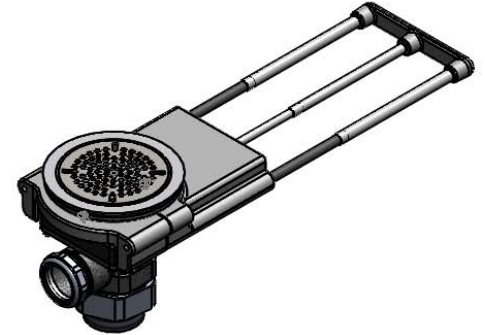

Features & Benefits:

- Modular push-pull waste valve for 3 1/2" sink opening w/ stainless steel body
- Modular design for easy installation and maintenance
- 2" NPT male outlet x 1 1/2" NPT BSP male adapter
- Push-pull handle with handle guard to endure extreme abuse
- 5" handle extension
- 3 1/2" snap-in removable strainer
- Installation tool included
- Handle extension kits available
- Material: Stainless steel body, stainless steel flat strainer and chrome plated metal handle guard

Product Compliance:

- ASME A112.18.2 / CSA B125.2



Warranty: Limited (Lifetime)

Performance Data:

- Discharge Rate: 28.50 GPM [107.88 L/min] max
- Temperature: 40 °F - 180 °F [4.44 °C - 82.2 °C]



T&S BRASS AND BRONZE WORKS, INC.



• 2 Saddleback Cove • Travelers Rest, SC 29690
 Ph 800-476-4103 • Fax 864-834-3518
 • Simi Valley, CA • Ph 800-423-0150 • www.tsbrass.com

Date: 02/09/23