



T&S BRASS AND BRONZE WORKS, INC.

2 Saddleback Cove / P.O. Box 1088
Travelers Rest, SC 29690

Model No.

B-0101-A84

Item No.

Travelers Rest, SC: 800-476-4103 • Simi Valley, CA: 800-423-0150 • Fax: 864-834-3518 • www.tsbrass.com

This Space for Architect/Engineer Approval

Job Name _____ Date _____

Model Specified _____ Quantity _____

Customer/Wholesaler _____

Contractor _____

Architect/Engineer _____

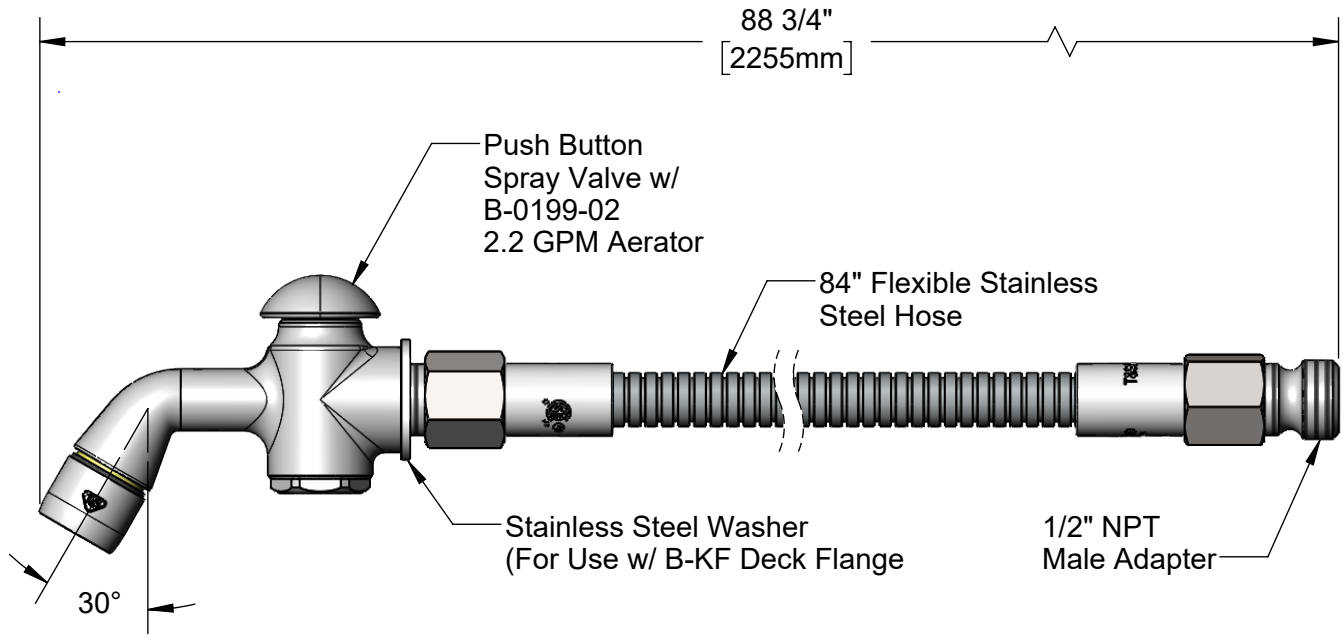
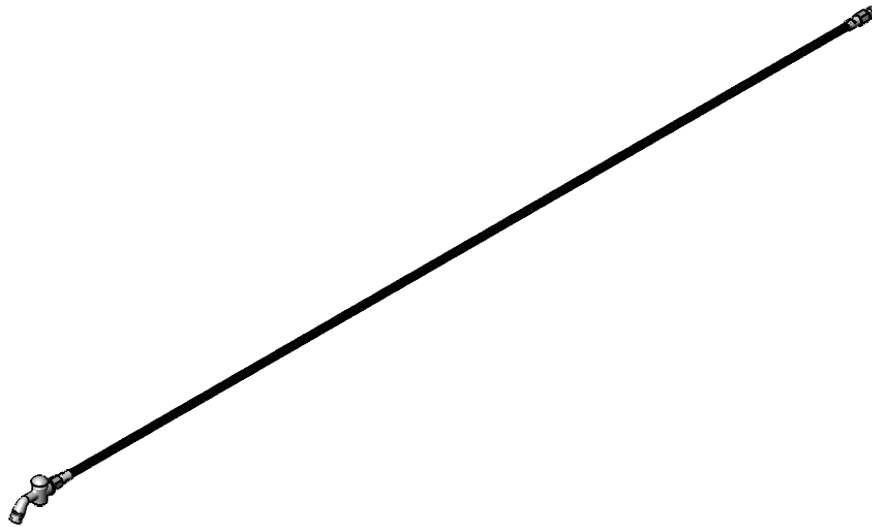

Product Specifications:

Push Button Spray Valve w/ 2.2 GPM Aerator & 84" Flexible Stainless Steel Hose w/ Adapter

Product Compliance:

ASME A112.18.1 / CSA B125.1
NSF 61 - Section 9
NSF 372 (Low Lead Content)
EPA Act 2005 Non-Compliant (PRSV)
Product Not Designed/Intended for Commercial Warewashing in North America



T&S BRASS AND BRONZE WORKS, INC.

2 Saddleback Cove / P.O. Box 1088
Travelers Rest, SC 29690

Model No.

B-0101-A84

Item No.

Travelers Rest, SC: 800-476-4103 • Simi Valley, CA: 800-423-0150 • Fax: 864-834-3518 • www.tsbrass.com

ITEM NO.	SALES NO.	DESCRIPTION
1	001043-45	Washer
2	002858-40	Push Button Spray Valve w/ 2.2 GPM Aerator
3	001010-40	Washer, Stainless Steel
4	010476-45	#27 Washer
5	055A	Adapter, 1/2 NPT Male
6	013E-84H	84" Flexible Stainless Steel Hose
7	044A	3/8" to Aerator Adapter
8	B-0199-02	2.2 GPM Aerator, 3/8" NPSM Male
9	B-0199-01	2.2 GPM Aerator, 55/64-27 UN Female

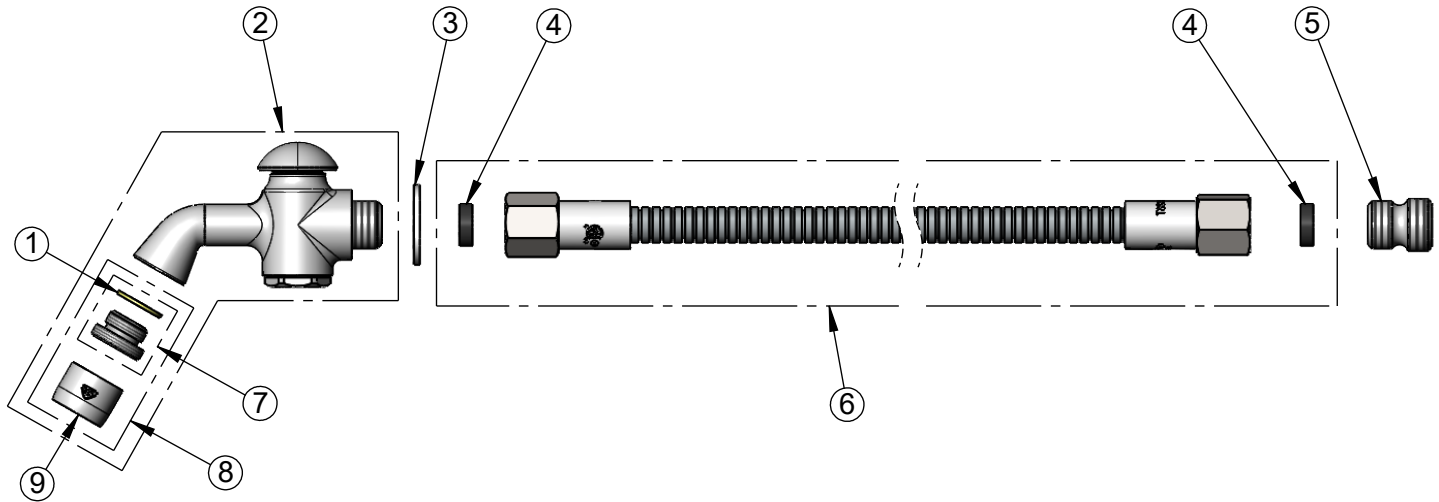

Product Specifications:
Push Button Spray Valve w/ 2.2 GPM Aerator & 84" Flexible Stainless Steel Hose w/ Adapter

Product Compliance:
ASME A112.18.1 / CSA B125.1
NSF 61 - Section 9
NSF 372 (Low Lead Content)
EPA Act 2005 Non-Compliant (PRSV)
Product Not Designed/Intended for Commercial Warewashing in North America