



Gas Hoses
HG-4E-48S

TAG:

SAFET-LINK Gas Hose

Architect/Engineering Specifications:

48" coated gas appliance connector hose with 1" NPT male connections, swivel fittings and quick-disconnect. Certified to ANSI Z21.69/CSA 6.16, NSF 2.

Job Name _____
 Model Specified _____ Quantity _____
 Variations Specified _____
 Date _____

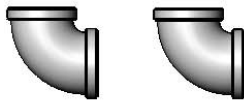
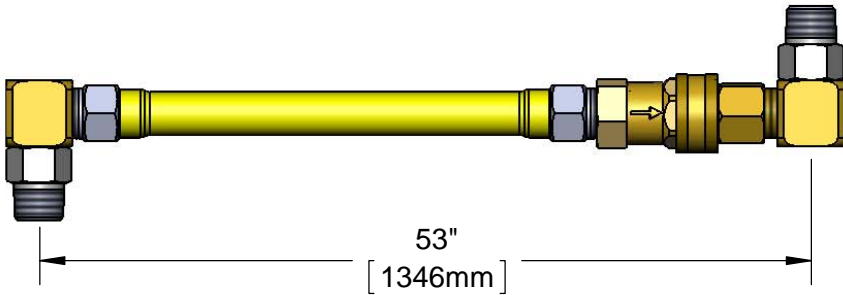
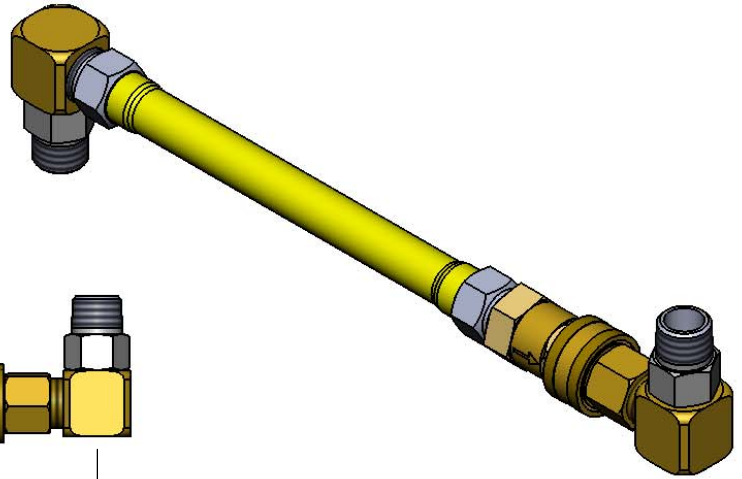

90° Elbows



Features & Benefits:

- 48" coated gas appliance connector w/ freespin fittings
- (2) 1" NPT male SwiveLink fittings
- (2) 90° elbows included
- 1" NPT male quick-disconnect
- 360° rotatable hex nut rotates completely and freely
- Optimum torsional relief improves safety, increases connector life
- No lock-up during use with SwiveLink fittings
- Quick-disconnect socket acts as shut-off valve when the plug and socket are disconnected
- Provides efficient, full gas flow
- Material: Extruded coated stainless steel braids

Product Compliance:

- ANSI Z21.69 / CSA 6.16
- NSF 2
- NFPA 54

Warranty: Five Year (Limited)

Performance Data:

- Pressure: 1/2 psi max
- Temperature: 350°F max w/ Fusible Link Thermal Shut-off
- Capacity: 335,000 BTU / hr min



T&S BRASS AND BRONZE WORKS, INC.



• 2 Saddleback Cove • Travelers Rest, SC 29690
 Ph 800-476-4103 • Fax 864-834-3518
 • Simi Valley, CA • Ph 800-423-0150 • www.tsbrass.com

Date: 10/21/15