



T&S BRASS AND BRONZE WORKS, INC.
 2 Saddleback Cove / P.O. Box 1088
 Travelers Rest, SC 29690

Model No.
B-2866-05CR-L15

Item No.

Travelers Rest, SC: 800-476-4103 • Simi Valley, CA: 800-423-0150 • Fax: 864-834-3518 • www.tsbrass.com



ADA Compliant

This Space for Architect/Engineer Approval

Job Name _____ Date _____

Model Specified _____ Quantity _____

Customer/Wholesaler _____

Contractor _____

Architect/Engineer _____

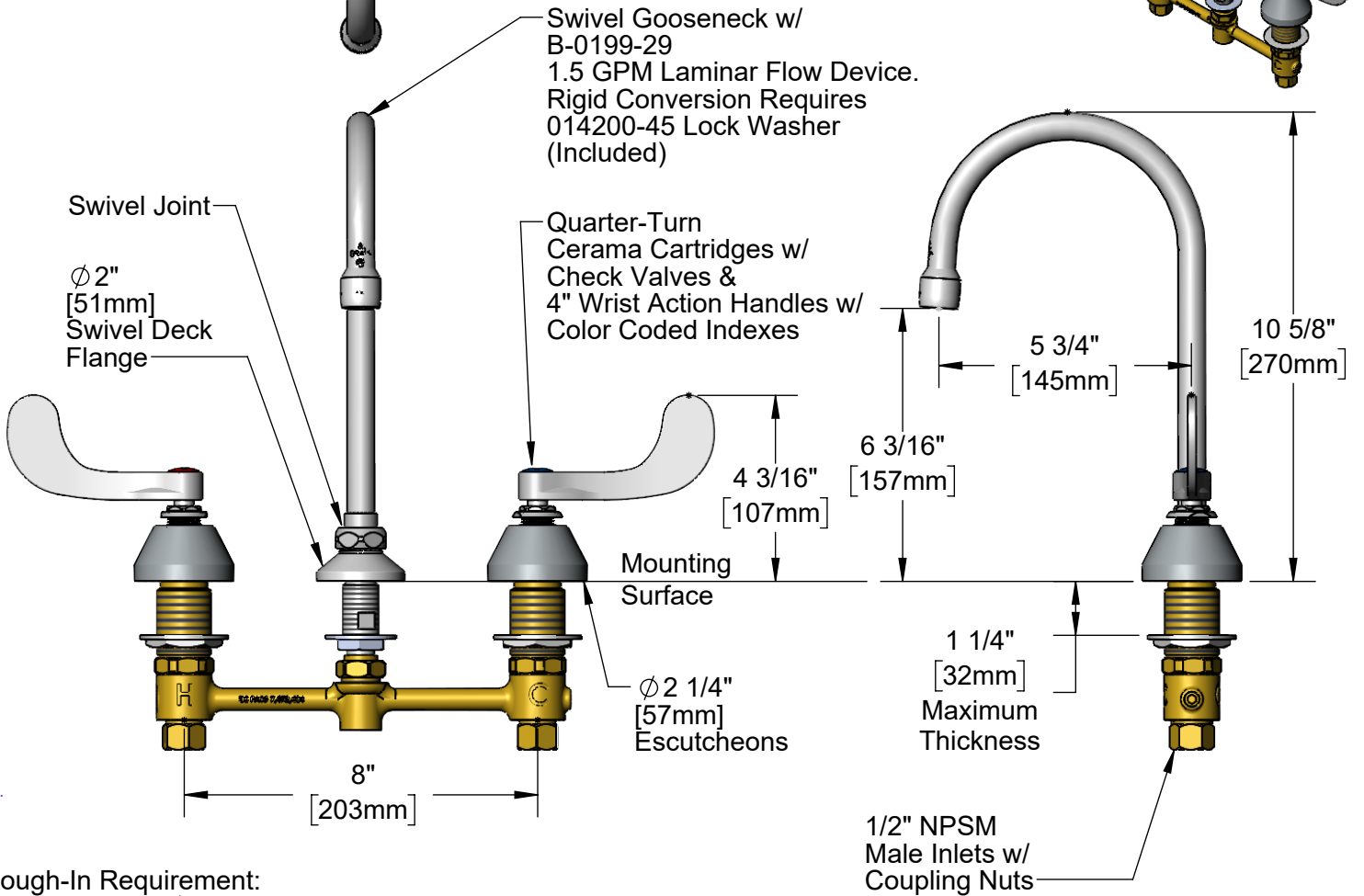
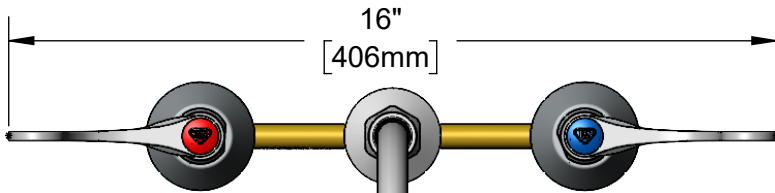

Rough-In Requirement:
 Center Shank: ϕ 1" [25mm] Mounting Hole
 Hot/Cold Side: ϕ 1 1/2" [38mm] Mounting Holes

Product Specifications:
 8" Deck Mount EasyInstall Mixing Faucet, Quarter-Turn Cerama Cartridges w/ Check Valves, 4" Wrist Action Handles, 5 3/4" Swivel/Rigid Gooseneck w/ 1.5 GPM Laminar Flow Device & 1/2" NPT Male Inlets

Product Compliance:
 ASME A112.18.1 / CSA B125.1
 NSF 61 - Section 9
 NSF 372 (Low Lead Content)
 ANSI A117.1 (ADA)
 EPA WaterSense



T&S BRASS AND BRONZE WORKS, INC.

2 Saddleback Cove / P.O. Box 1088
Travelers Rest, SC 29690

Model No.

B-2866-05CR-L15

Item No.

Travelers Rest, SC: 800-476-4103 • Simi Valley, CA: 800-423-0150 • Fax: 864-834-3518 • www.tsbrass.com

ITEM NO.	SALES NO.	DESCRIPTION
1	B-0199-29	1.5 GPM Laminar Flow Device, 55/64-27 UN Female
2	009538-45	Swivel Washer
3	011429-45	Swivel Sleeves (2)
4	001074-45	O-Ring
5	014200-45	Star Washer, Anti-Rotation
6	016754-40	EasyInstall CWS Swivel Center Shank
7	016742-45	Center Flange Nut
8	016745-45	Compression Nut & Fitting
9	018506-19NS	Blue Button Index, Press-in
10	000925-45	Lab Handle Screw
11	B-WH4C-NS	Wrist Action Handle, Blue Index & Screw
12	B-WH4-NS	Wrist Action Handle - New Style
13	001257-40NS	Bell Escutcheon
14	016768-25NS	EasyInstall, CWS Quarter-Turn Cerama Cartridge w/ Check Valve, LTC
15	016749-45	Sidebody C-Washer
16	016777-45	CWS Hanger
17	000958-20	Coupling Nut
18	016767-25NS	EasyInstall, CWS Quarter-Turn Cerama Cartridge w/ Check Valve, RTC
19	016743-20	CWS Bonnet
20	009002-40NS	Packing Assembly (New Style)
21	B-WH4H-NS	Wrist Action Handle, Red Index & Screw
22	001193-19NS	Red Button Index, Press-in

017245-40
Installation Repair Kit
Includes #7, (2)#15 & #16

Product Specifications:
8" Deck Mount EasyInstall Mixing Faucet, Quarter-Turn Cerama Cartridges w/ Check Valves, 4" Wrist Action Handles, 5 3/4" Swivel/Rigid Gooseneck w/ 1.5 GPM Laminar Flow Device & 1/2" NPT Male Inlets

Product Compliance:
ASME A112.18.1 / CSA B125.1
NSF 61 - Section 9
NSF 372 (Low Lead Content)
ANSI A117.1 (ADA)
EPA WaterSense