

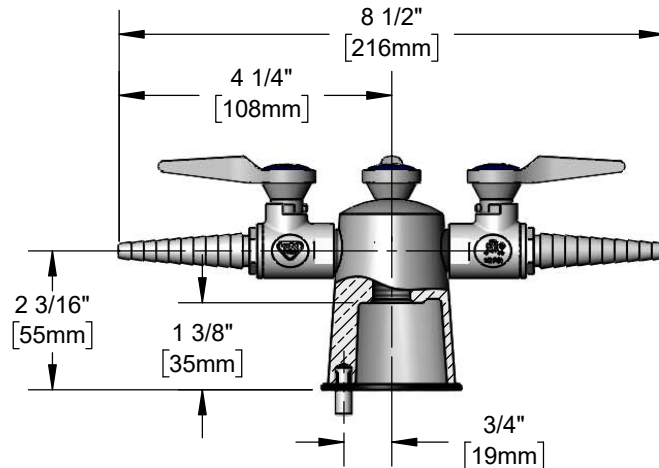

**Architect/Engineering Specifications:**

Laboratory turret with polished chrome plated brass body, vandal resistant anti-rotation pin, (3) ball valve hose cocks with polished chrome plated brass bodies, handles & serrated tip outlets at 90 degrees, and 3/8" NPT female inlet. Certified to ANSI Z21.15a / CSA 9.1a. Meets ADA ANSI/ICC A117.1 requirements.

Job Name \_\_\_\_\_  
 Model Specified \_\_\_\_\_ Quantity \_\_\_\_\_  
 Variations Specified \_\_\_\_\_  
 Date \_\_\_\_\_

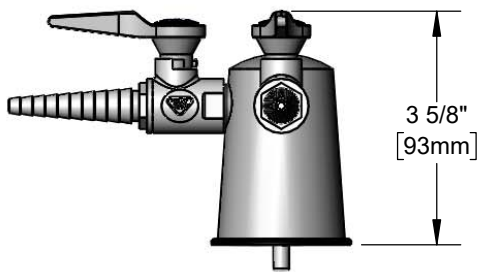
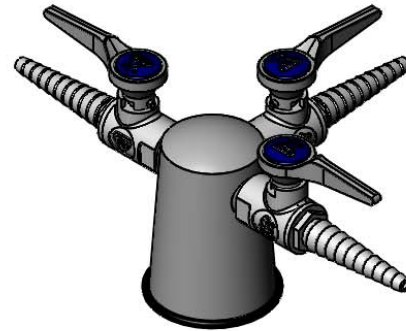

**Features & Benefits:**

- Laboratory turret with polished chrome plated brass body
- Vandal resistant anti-rotation pin
- (3) Ball valve hose cocks w/ polished chrome plated brass bodies & handles
- (3) Serrated tip outlets at 90 degrees, fits 1/4" to 3/8" I.D. hoses
- For natural gas above 0.5 psig or Oxygen and specialty gases, use BL-4010-01 gas cock
- Press-in color coded indexes (gas, vacuum & air included)
- 3/8" NPT female inlet in base
- Black plastic base gasket
- Material: Polished chrome plated brass body

**Product Compliance:**

- ANSI Z21.15a / CSA 9.1a (Gas Valves)
- ANSI A117.1 (ADA)

**Warranty:** One Year (Limited)

**Performance Data:**

- Pressure:
  - Gas - 0.5 psig max
  - Air - 125 psig max
  - Vacuum - 30 inches of Mercury max
- Temperature: 32 °F - 125 °F



**ADA Compliant**

