

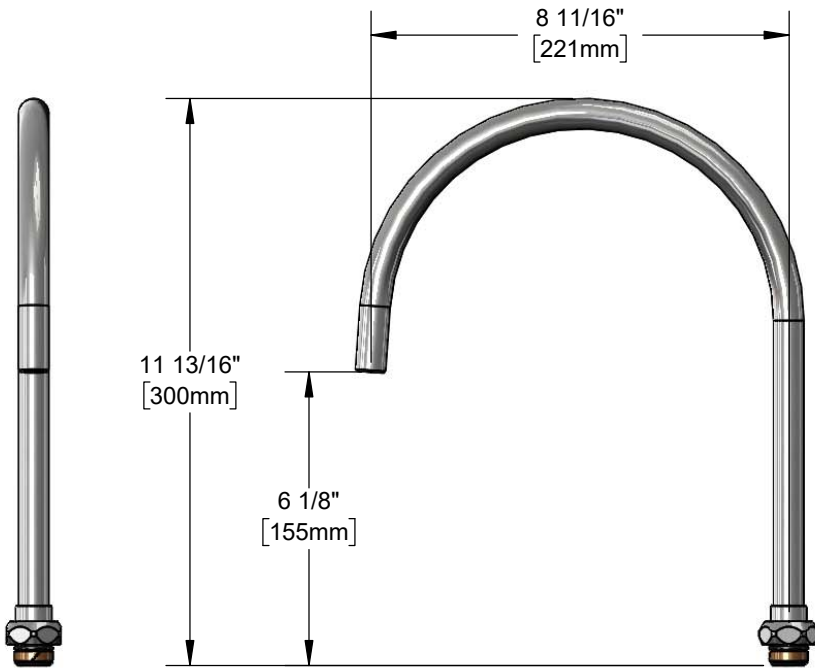

Architect/Engineering Specifications:

8 11/16" plain end laminar swivel gooseneck with 0.5 GPM flow disc in swivel piece. Certified to ASME A112.18.1/CSA B125.1, NSF 61-Section 9 and NSF 372.

Job Name _____
 Model Specified _____ Quantity _____
 Variations Specified _____
 Date _____



Features & Benefits:

- 8 11/16" plain end laminar swivel gooseneck
- 0.5 GPM flow disc
- Fits all T&S swivel outlet faucets
- Material: Chrome plated brass tubular spout

Product Compliance:

- ASME A112.18.1 / CSA B125.1
- NSF 61 - Section 9
- NSF 372 (Low Lead Content)



Warranty: One Year (Limited)

Performance Data:

- Pressure: 20 - 125 psi
- Temperature: 40 °F - 140 °F
- Flow Rate: 0.5 GPM @ 60 psi

Optional Flow Disc

GPM	Model No
0.5	Standard
1.0	<input type="checkbox"/> FD10
1.2	<input type="checkbox"/> FD12
1.5	<input type="checkbox"/> FD15
2.2	<input type="checkbox"/> FD22

