



T&S BRASS AND BRONZE WORKS, INC.
 2 Saddleback Cove / P.O. Box 1088
 Travelers Rest, SC 29690

Model No.

B-0020-H-SWV

Item No.

Travelers Rest, SC: 800-476-4103 • Simi Valley, CA: 800-423-0150 • Fax: 864-834-3518 • www.tsbrass.com

This Space for Architect/Engineer Approval

Job Name _____ Date _____

Model Specified _____ Quantity _____

Customer/Wholesaler _____

Contractor _____

Architect/Engineer _____

3/4-14 UN
Female Outlet

3/4-14 UN
Female Inlet

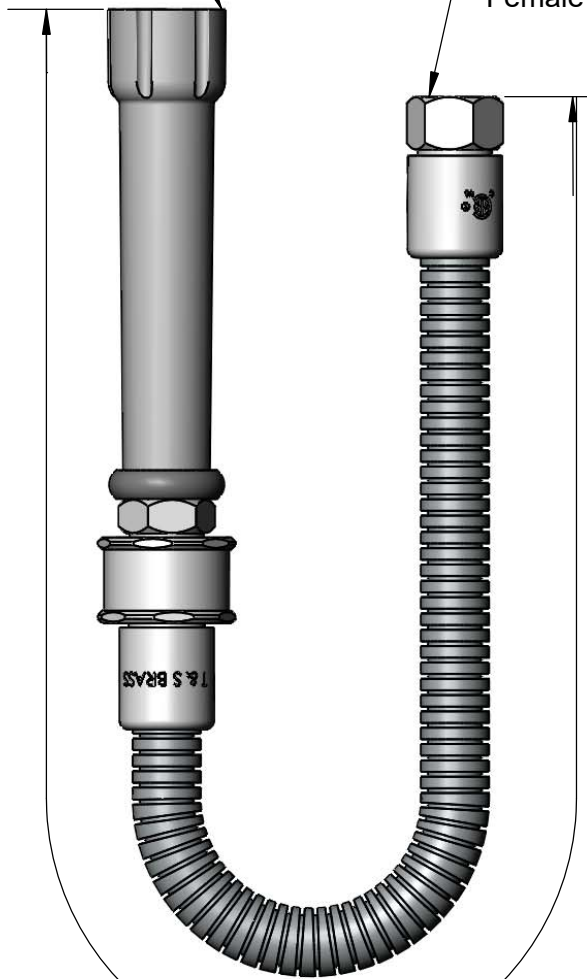

20 15/16"
[532mm]



(2) 010476-45
Washers
(Included)

Product Specifications:

20" Stainless Steel Flex Hose w/ Gray Handle, Swivel & Polyurethane Inner Hose

Product Compliance:

ASME A112.18.1 / CSA B125.1
 NSF 61 - Section 9
 NSF 372 (Low Lead Content)



T&S BRASS AND BRONZE WORKS, INC.
 2 Saddleback Cove / P.O. Box 1088
 Travelers Rest, SC 29690

Model No.
B-0020-H-SWV

Item No.

Travelers Rest, SC: 800-476-4103 • Simi Valley, CA: 800-423-0150 • Fax: 864-834-3518 • www.tsbrass.com

ITEM NO.	SALES NO.	DESCRIPTION
1	001014-45	Washer, B-0100 Hose Barrel
2	018200-40	Pre-Rinse Swivel
3	002987-40	Gray Grip Handle
4	010476-45	#27 Washer
5	000729-40	Nut, 7/8-20 Male x 3/4-14 Female

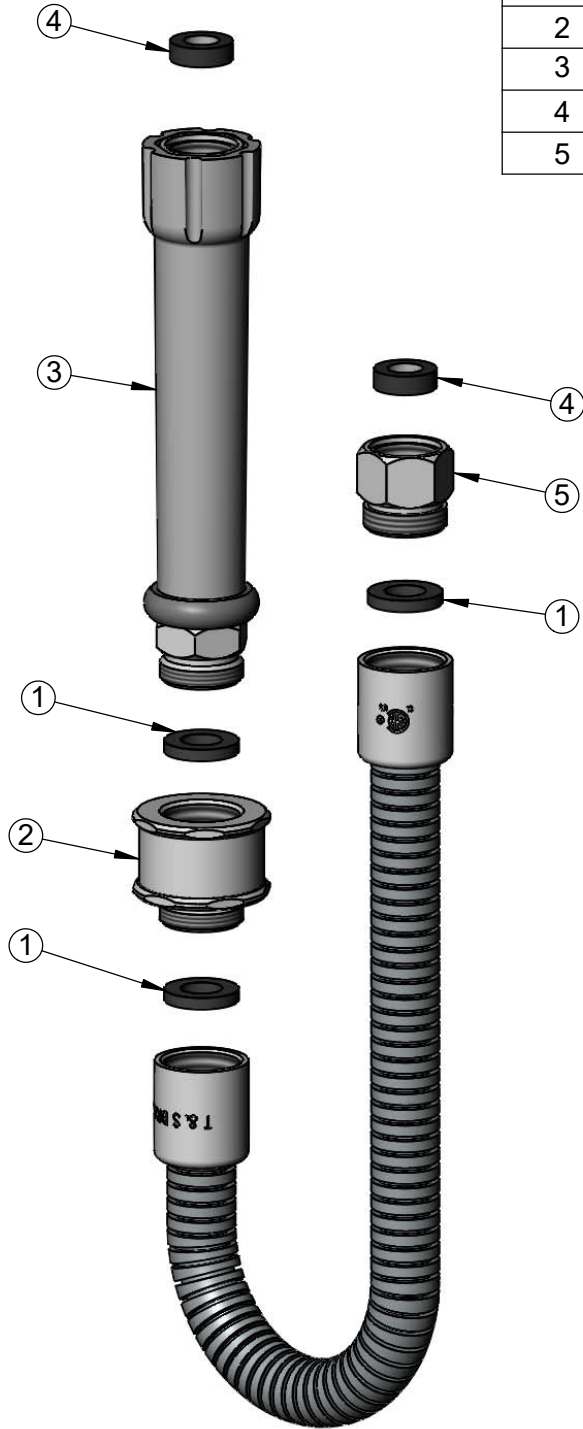

Product Specifications:
 20" Stainless Steel Flex Hose w/ Gray Handle, Swivel & Polyurethane Inner Hose

Product Compliance:
 ASME A112.18.1 / CSA B125.1
 NSF 61 - Section 9
 NSF 372 (Low Lead Content)