



Architect/Engineering Specifications:

4" faucet inlet extension with 1/2" NPT female eccentric inlet and flanged coupling nut outlet. Certified to ASME A112.18.1/CSA B125.1, NSF 61-Section 9 and NSF 372.

Job Name _____

Model Specified _____ Quantity _____

Variations Specified _____

Date _____

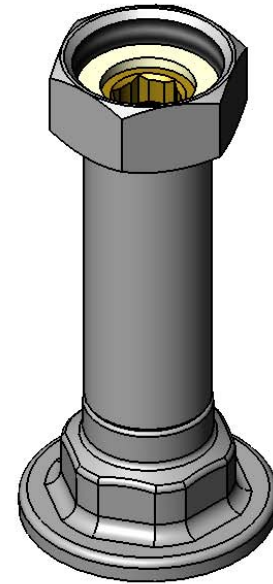
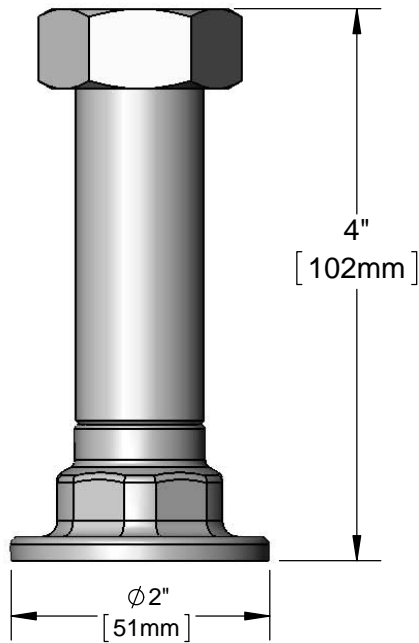

Features & Benefits:

- 4" faucet inlet extension
- 1/2" NPT female eccentric inlet
- Flanged coupling nut outlet fits standard T&S faucet bodies
- Adds 2 3/4" length to standard 00AA inlet
- Material: Polished chrome plated brass

Product Compliance:

- ASME A112.18.1 / CSA B125.1
- NSF 61 - Section 9
- NSF 372 (Low Lead Content)

Warranty: One Year (Limited)

Performance Data:

- N/A

