



Architect/Engineering Specifications:

1.5 GPM vandal resistant aerator with polished chrome plated brass body, 13/16-27 UN male thread. Certified to ASME A112.18.1/CSA B125.1, NSF 61-Section 9 and NSF 372.

Job Name _____

Model Specified _____ Quantity _____

Variations Specified _____

Date _____

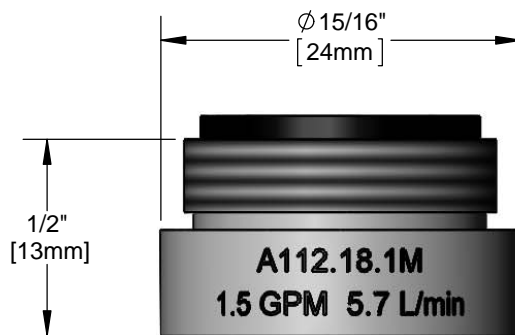

Features & Benefits:

- 1.5 GPM vandal resistant aerator
- 13/16-27 UN male threads, Series 8
- Vandal resistant key included
- Material: Polished chrome plated brass body

Product Compliance:

- ASME A112.18.1 / CSA B125.1
- NSF 61 - Section 9
- NSF 372 (Low Lead Content)



Warranty: One Year (Limited)

Performance Data:

- Pressure: 20 - 125 psi
- Temperature: 40°F - 140°F
- Flow Rate: 1.5 GPM @ 60 psi

