



Architect/Engineering Specifications:

0.5 GPM vandal resistant non-aerated spray device with polished chrome plated brass body and 13/16-24 UN female inlet. Certified to ASME A112.18.1/CSA B125.1, NSF 61-Section 9 and NSF 372.

Job Name _____

Model Specified _____ Quantity _____

Variations Specified _____

Date _____

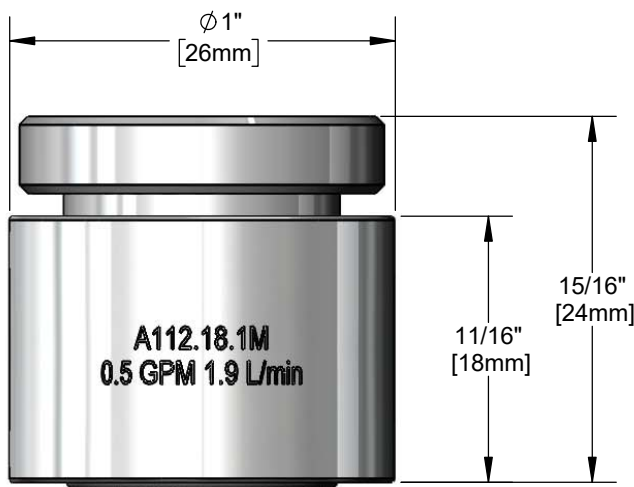

Features & Benefits:

- 0.5 GPM vandal resistant non-aerated spray device w/ polished chrome plated brass body
- 13/16-24 UN female inlet, Series 10
- Vandal resistant key included
- Material: Polished chrome plated brass body

Product Compliance:

- ASME A112.18.1 / CSA B125.1
- NSF 61 - Section 9
- NSF 372 (Low Lead Content)



Warranty: One Year (Limited)

Performance Data:

- Pressure: 20 - 125 psi
- Temperature: 40 °F - 140 °F
- Flow Rate: 0.5 GPM @ 60 psi

