

#### Architect/Engineering Specifications:

Single hole deck mount mixing faucet with polished chrome plated brass body, add-on faucet with ceramic cartridge and lever handle, 14 1/8" swing nozzle with laminar flow device, 18" riser, 44" flexible stainless steel hose with heat resistant handle, 1.15 GPM spray valve, ceramic cartridges, lever handles, 1/2" BSPP check valves, 18" flexible stainless steel supply hoses with 1/2" NPSM / 5/8" compression connections, 6" adjustable wall bracket, spray valve holder and overhead spring. Certified to ASME A112.18.1/CSA B125.1, NSF 61-Section 9 and NSF 372. 2019 DOE PRSV - Class II compliant.

Job Name \_\_\_\_\_  
 Model Specified \_\_\_\_\_ Quantity \_\_\_\_\_  
 Variations Specified \_\_\_\_\_  
 Date \_\_\_\_\_

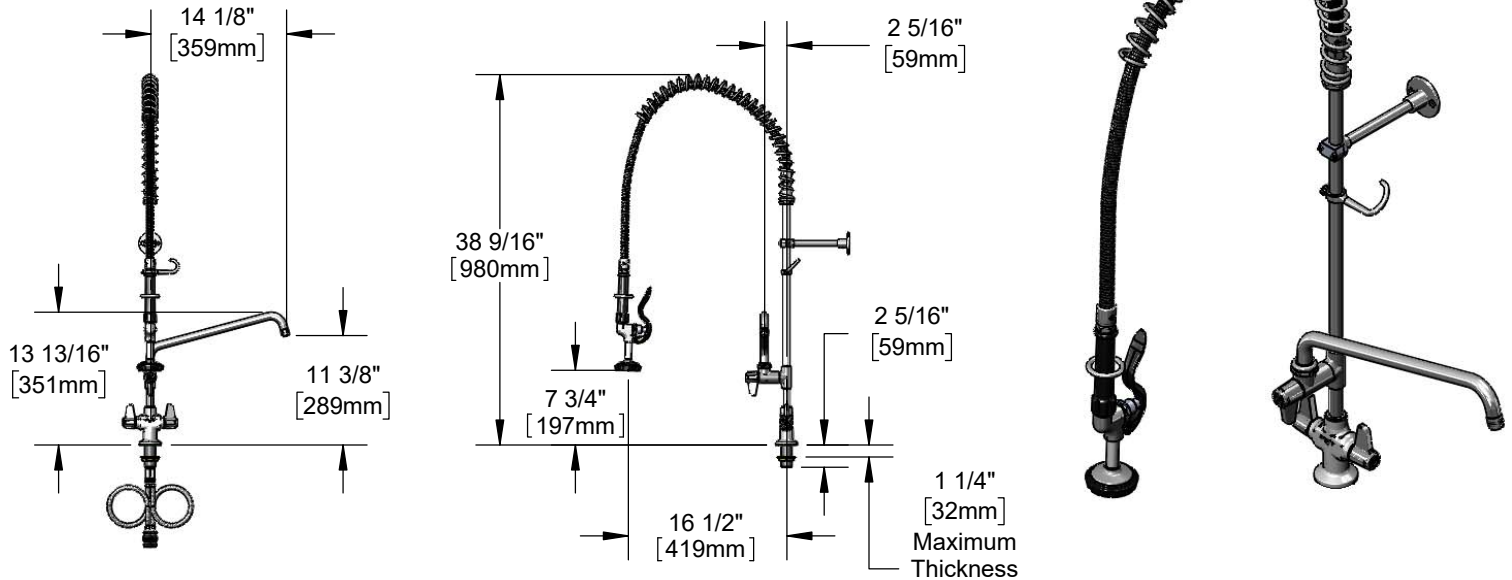

#### Features & Benefits:

- Single hole deck mount mixing faucet w/ polished chrome plated brass body & Ø 2 1/4" Deck Flange
- Add-on faucet w/ polished chrome plated brass body
- 14 1/8" swing nozzle w/ laminar flow device
- 18" rigid riser
- 44" flexible stainless steel hose w/ heat resistant black handle and hold down ring
- 1.15 GPM spray valve
- Quarter-turn ceramic cartridges
- Lever handles w/ color coded screws
- 1/2" BSPP check valves
- 18" flexible stainless steel supply hoses w/ 1/2" NPSM / 5/8" compression connections
- 6" adjustable wall bracket
- Material: Polished chrome plated brass body & tubular nozzle, add-on faucet body, riser & spray valve, stainless steel hose and chrome plated metal handles

#### Product Compliance:

- ASME A112.18.1 / CSA B125.1
- NSF 61 - Section 9
- NSF 372 (Low Lead Content)
- 2019 DOE PRSV - Class II

**Warranty:** One Year (Limited)

#### Performance Data:

- Pressure: 20 - 125 psi
- Temperature: 40 °F - 140 °F
- Flow Rate:
  - Spray Valve: 1.15 GPM @ 60 psi
  - Add-On Faucet: 3.83 GPM @ 60 psi

