



Stainless Steel Retractable Hose Reels

B-7143-07

TAG:

Open Stainless Steel Hose Reel

Architect/Engineering Specifications:

Open stainless steel hose reel, stainless steel front trigger water gun and swivel with 9/16" orifice and 1/2" NPT female inlet, 1/2" x 50' heavy-duty non-marking hose, ratcheting system, multi-fit bracket, adjustable hose bumper and 1/2" NPT female inlet.

Job Name	_____		
Model Specified	_____	Quantity	_____
Variations Specified	_____		
Date	_____		

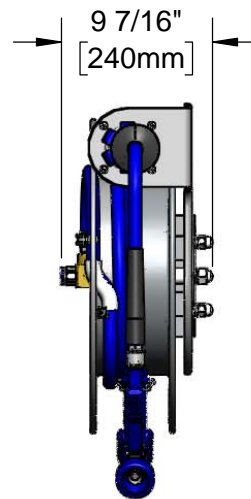
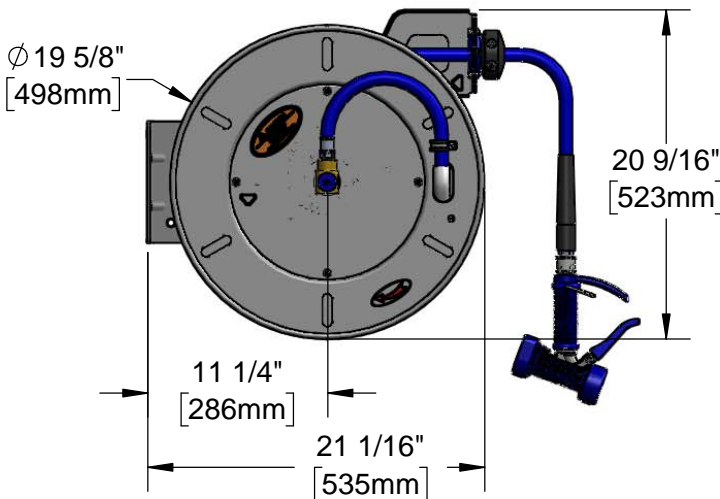

Features & Benefits:

- Open stainless steel hose reel
- Stainless steel front trigger water gun and swivel with 9/16" orifice and 1/2" NPT female inlet
- 1/2" x 50' heavy-duty non-marking hose rated to 300 PSI
- Ratcheting system holds the length of hose until a slight tug to retract automatically
- 1/2" NPT female inlet
- Adjustable hose bumper
- Multi-fit bracket for wall, ceiling or under counter mounting
- Material: Stainless steel open reel, water gun and wall bracket

Product Compliance:

- NSF 61 Exempt (Non-Potable)

Warranty: Two Year (Limited)

- Hose: One Year (Limited)

Performance Data:

- Pressure: 20 - 125 psi
- Temperature: 40 °F - 200 °F
- Flow Rate: 6.84 GPM @ 60 psi

Optional Hose Reel Spray Valves

- MV-2516-44 Stainless Steel Rear Trigger Water Gun
- MV-2522-44 Stainless Steel Front Trigger Water Gun (Standard)
- EB-0107 High Flow Spray Valve

Optional Hose Reel Multi-Fit Brackets

1/4", 3/8", & 1/2" Stainless Steel Hose Reel

- G016737-45 Stainless Steel Wall Swing Bracket
- G016652-45 Deck Mount Pivot Bracket
- G018477-45 Stainless Steel Table Leg Swing Bracket



T&S BRASS AND BRONZE WORKS, INC.



• 2 Saddleback Cove • Travelers Rest, SC 29690
 Ph 800-476-4103 • Fax 864-834-3518
 • Simi Valley, CA • Ph 800-423-0150 • www.tsbrass.com

Date: 10/09/17