



ADA Compliant

This Space for Architect/Engineer Approval

Job Name _____ Date _____

Model Specified _____ Quantity _____

Customer/Wholesaler _____

Contractor _____

Architect/Engineer _____

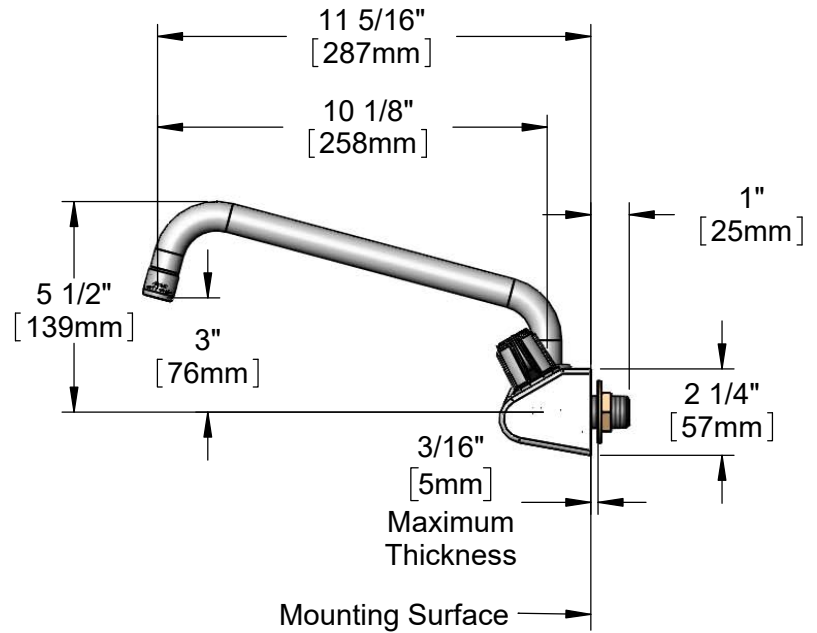
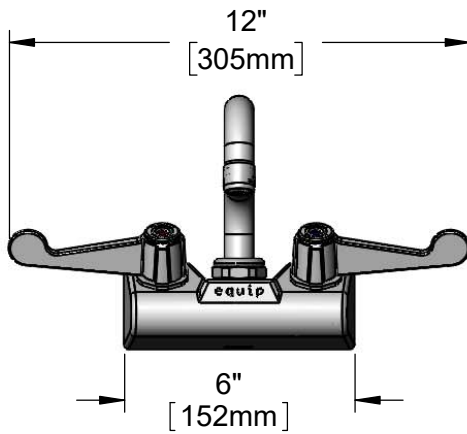
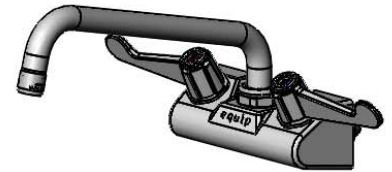
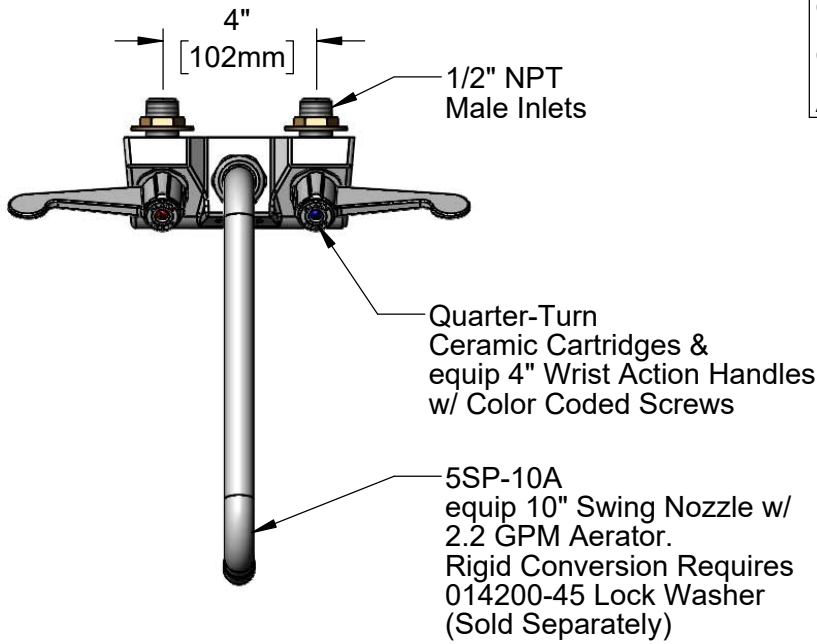

Rough-In Requirement:
(2) ϕ 1" [25mm] Mounting Holes

Model Number
5F-4WWX10

Product Specifications:
4" Wall Mount Mixing Faucet w/ Quarter-Turn Ceramic Cartridges, equip 4" Wrist Action Handles, 10" Swing Nozzle w/ 2.2 GPM Aerator & 1/2" NPT Male Inlets

Product Compliance:
ASME A112.18.1 / CSA B125.1
NSF 61 - Section 9
NSF 372 (Low Lead Content)
ANSI A117.1 (ADA)

equip Foodservice Accessories

2 Saddleback Cove, P.O. Box 1088
Travelers Rest, South Carolina 29690
Phone: 800.891.4808 Fax: 800.868.0084
equip.tsbrass.com

ITEM NO.	SALES NO.	DESCRIPTION
1	5SP-10A	equip 10" Swing Nozzle w/ 2.2 GPM Aerator
2	013838-45	Aerator, 3/4-27 Female, 2.2 GPM
3	013839-25	equip Swivel Nut
4	013848-45	equip Swivel Piece O-Ring
5	017587-45	Swivel Nut Seal
6	5-HDL-W	equip 4" Wrist Action Handle w/ Color Coded Screws
7	013788-45	equip Quarter-Turn Ceramic Cartridge, LTC
8	000999-45	Brass Lock Washer
9	002954-45	Shank Lock Nut
10	013787-45	equip Quarter-Turn Ceramic Cartridge, RTC

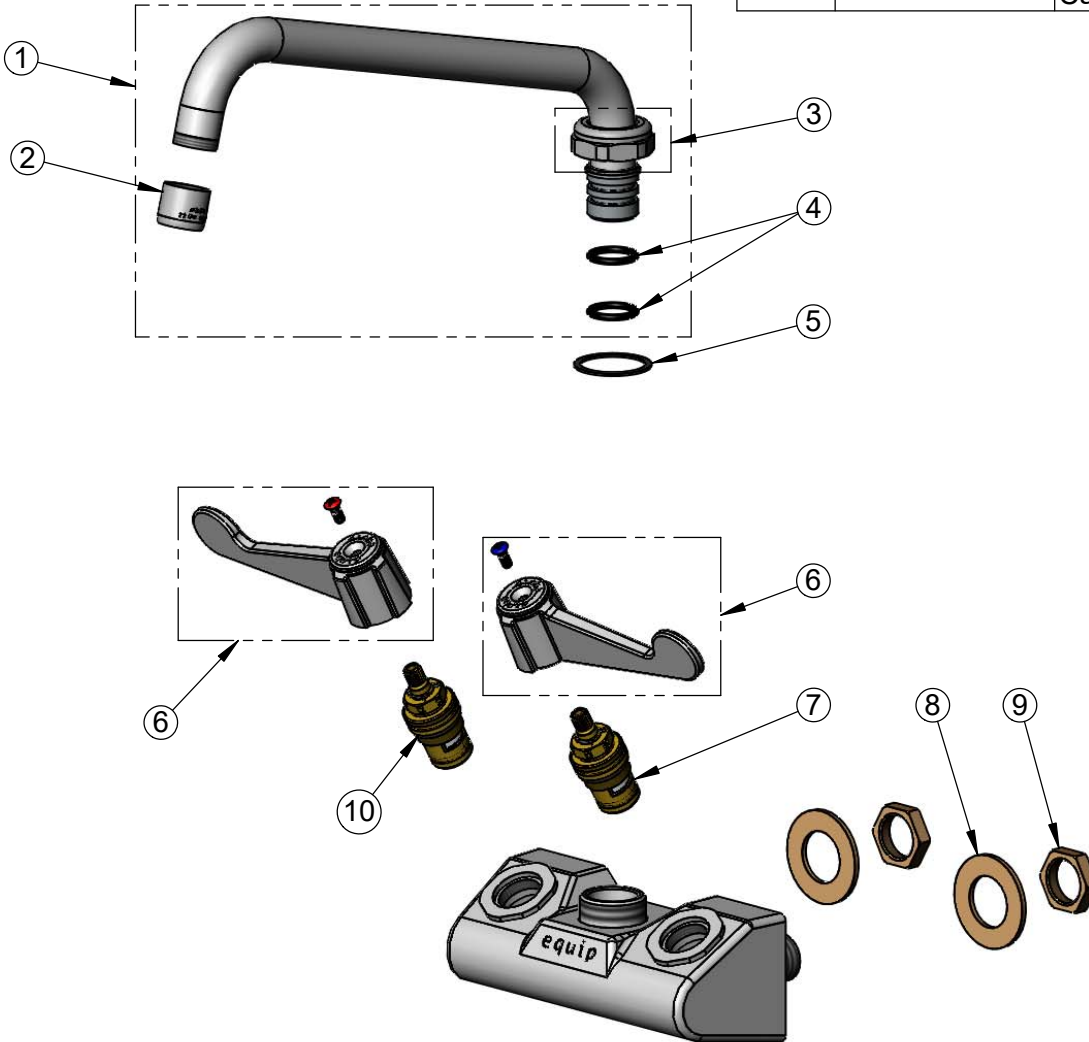

Model Number

5F-4WWX10

Product Specifications:

4" Wall Mount Mixing Faucet w/ Quarter-Turn Ceramic Cartridges, equip 4" Wrist Action Handles, 10" Swing Nozzle w/ 2.2 GPM Aerator & 1/2" NPT Male Inlets

Product Compliance:

ASME A112.18.1 / CSA B125.1
NSF 61 - Section 9
NSF 372 (Low Lead Content)
ANSI A117.1 (ADA)

equip
Foodservice
Accessories

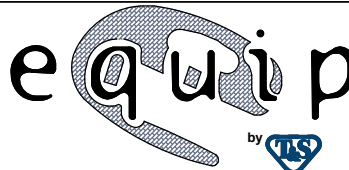

2 Saddleback Cove, P.O. Box 1088
Travelers Rest, South Carolina 29690
Phone: 800.891.4808 Fax: 800.868.0084
equip.tsbrass.com