



Service Sink / Mop Sink Faucets

B-0650-POL

TAG:

Service Sink Faucet

Architect/Engineering Specifications:

8" wall mount mixing faucet with polished chrome plated brass body, polished chrome plated brass spout with pail hook and plain end outlet, compression cartridges with spring checks, lever handles, 1/2" NPT female extension inlets and lower support rod. Certified to ASME A112.18.1/CSA B125.1, NSF 61-Section 9 and NSF 372. Meets ADA ANSI/ICC A117.1 requirements.

Job Name _____
 Model Specified _____ Quantity _____
 Variations Specified _____
 Date _____

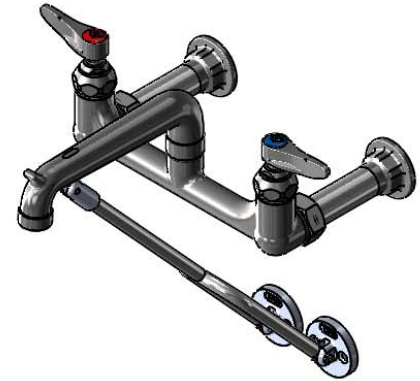
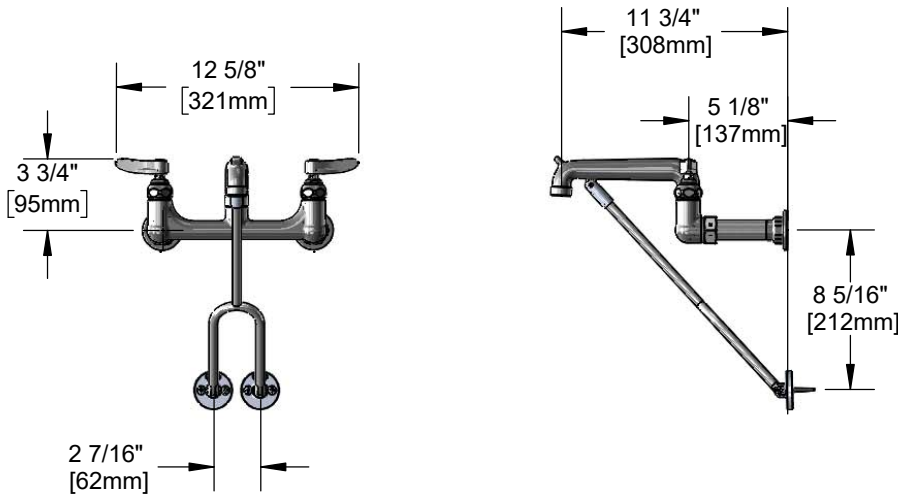

Features & Benefits:

- 8" wall mount mixing faucet with polished chrome plated brass body
- Spout with pail hook & plain end outlet
- Lever handles with color coded indexes
- Quarter-turn Eterna compression cartridges with spring checks to prevent cross flow of water
- 1/2" NPT eccentric female inlets w/ Ø2" flanges & 2 3/4" extensions
- Adjustable centers from 7 3/4" to 8 1/4"
- Lower support rod
- Material: Polished chrome plated brass body, spout, inlets & support rods and chrome plated metal handles

Product Compliance:

- ASME A112.18.1 / CSA B125.1
- NSF 61 - Section 9
- NSF 372 (Low Lead Content)
- ANSI A117.1 (ADA)

Warranty: One Year (Limited)

Performance Data:

- Pressure: 20 - 125 psi
- Temperature: 40 °F - 140 °F
- Flow Rate: 11.50 GPM @ 60 psi



ADA Compliant

Optional Handles

- 4" Wrist Action
- Lever (Standard)
- 4-Arm

Optional Cartridges With Checks

- Quarter-Turn Cerama w/ Check Valve
- Quarter-Turn Eterna w/ Spring Check (Standard)



T&S BRASS AND BRONZE WORKS, INC.



• 2 Saddleback Cove • Travelers Rest, SC 29690
 Ph 800-476-4103 • Fax 864-834-3518
 • Simi Valley, CA • Ph 800-423-0150 • www.tsbrass.com

Date: 11/02/18