



Architect/Engineering Specifications:

Single hole deck mount mixing faucet with polished chrome plated brass body, add-on faucet with compression cartridge and lever handle, 8" swing nozzle with stream regulator outlet, 24" riser, 44" flexible stainless steel hose, 1.07 GPM spray valve with insulated grip handle, compression cartridges with spring checks, lever handles, 18" flexible stainless steel supply hoses with 1/2" NPSM / 5/8" O.D. compression connections, spray valve holder and overhead spring. Certified to ASME A112.18.1/CSA B125.1, NSF 61-Section 9 and NSF 372. 2019 DOE PRSV - Class II compliant.

Job Name _____

Model Specified _____ Quantity _____

Variations Specified _____

Date _____

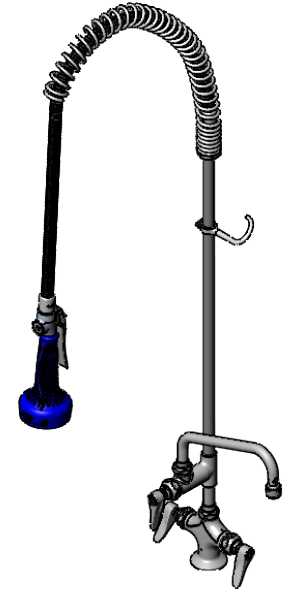
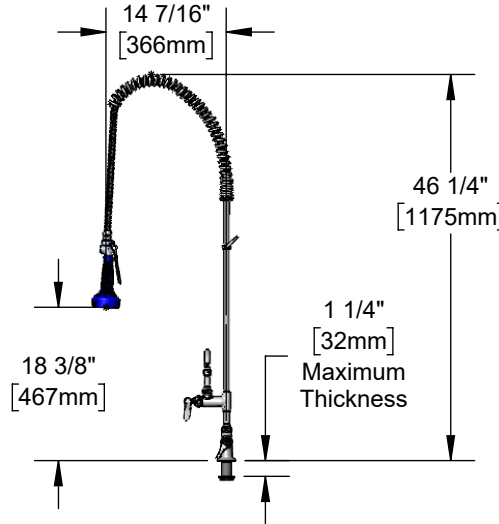
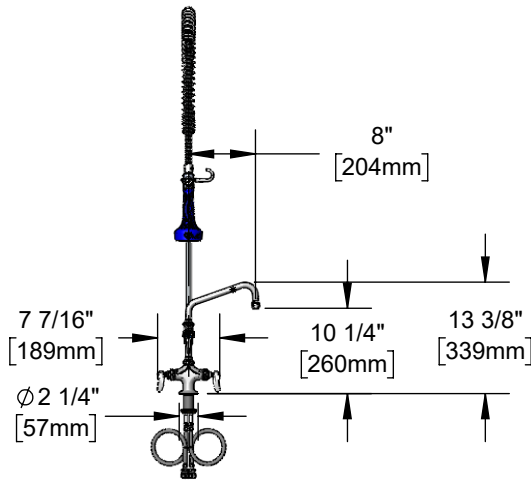

Features & Benefits:

- Single hole deck mount w/ polished chrome plated brass body
- EasyInstall add-on faucet w/ polished chrome plated brass body
- 8" swing nozzle w/ stream regulator outlet, Series 1
- 24" rigid riser
- 44" flexible stainless steel hose
- 1.07 GPM JeTSpray spray valve with insulated grip handle, stainless steel trigger and trigger lock
- Quarter-turn Eterna compression cartridges w/ spring checks to prevent cross flow of water
- Lever handles w/ color coded indexes
- 18" flexible stainless steel supply hoses with 1/2" NPSM / 5/8" O.D. compression connections
- Material: Polished chrome plated brass body, add-on faucet, riser and spray valve, stainless steel hose & chrome plated metal handles

Product Compliance:

- ASME A112.18.1 / CSA B125.1
- NSF 61 - Section 9
- NSF 372 (Low Lead Content)
- 2019 DOE PRSV - Class II



Warranty: Three Year (Limited)

Performance Data:

- Pressure: 20 - 125 psi [1.38 - 8.62 bar]
- Temperature: 40°F - 140°F [4.44°C - 60°C]
- Flow Rate:
 - Spray Valve: 1.07 GPM [4.05 L/min] @ 60 psi [4.14 bar]
 - Add-On Faucet: 5.57 GPM [21.08 L/min] @ 60 psi [4.14 bar]

Optional Add-On Faucet Outlets (Series 1 / VR Series 6)

GPM	Aerated	VR Aerated (VR Laminar)
1.0	<input type="checkbox"/> B-0199-01-F10	<input type="checkbox"/> B-0199-06-F10
1.5	<input type="checkbox"/> B-0199-01-WS	<input type="checkbox"/> B-0199-06-WS
2.2	<input type="checkbox"/> B-0199-01	<input type="checkbox"/> B-0199-06

Optional Cartridges With Checks

- Quarter-Turn Cerama w/ Check Valve
- Quarter-Turn Eterna w/ Spring Check (Standard)

Optional Handles

- 4" Wrist Action
- Lever (Standard)
- 4-Arm

Optional Pre-Rinse Spray Valves

- B-0107 (1.15 GPM)
- B-0107-C (0.65 GPM)
- B-0107-J (1.07 GPM)
- B-0108 (1.07 GPM) (Standard)
- B-0108-C (0.65 GPM)

