



Pre-Rinse Accessories

5AFL06

TAG:

Add-On Faucet

Architect/Engineering Specifications:

Add-on faucet with polished chrome plated brass body, 3/8" NPT female outlet, 6" swing nozzle with laminar full flow device, ceramic cartridge, lever handle and 3/8" NPT male inlet. Certified to ASME A112.18.1/CSA B125.1, NSF 61-Section 9 and NSF 372. Meets ADA ANSI/ICC A117.1 requirements.

Job Name _____
 Model Specified _____ Quantity _____
 Variations Specified _____
 Date _____

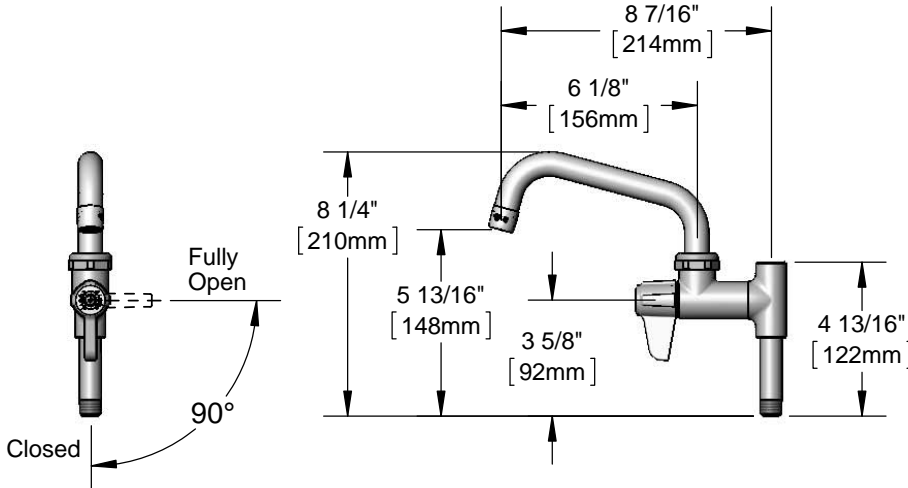
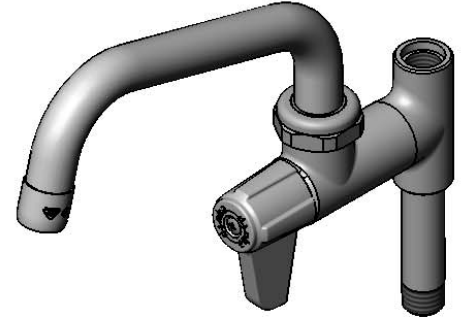

Features & Benefits:

- Add-on faucet w/ polished chrome plated brass body
- 3/8" NPT female outlet
- 6" equip swing nozzle w/ laminar full flow device
- Quarter-turn ceramic cartridge
- equip lever handle
- 3" nipple w/ 3/8" NPT male inlet
- Material: Polished chrome plated brass body, tubular spout, nipple and chrome plated metal handle

Product Compliance:

- ASME A112.18.1 / CSA B125.1
- NSF 61 - Section 9
- NSF 372 (Low Lead Content)
- ANSI A117.1 (ADA)

Warranty: One Year (Limited)

Performance Data:

- Pressure: 20 - 125 psi
- Temperature: 40 °F - 140 °F
- Flow Rate: 4.52 GPM @ 60 psi



ADA Compliant



equip Foodservice Accessories



• 2 Saddleback Cove • Travelers Rest, SC 29690
 Ph 800-891-4808 • Fax 800-868-0084
 www.tsbrass.com

Date: 10/24/16