



Architect/Engineering Specifications:

Chrome plated brass 8" swing nozzle with 3/8" NPT Inlet, stream regulator outlet and swivel body. Certified to ASME A112.18.1/CSA B125.1, NSF 61-Section 9 and NSF 372.

Job Name _____

Model Specified _____ Quantity _____

Variations Specified _____

Date _____

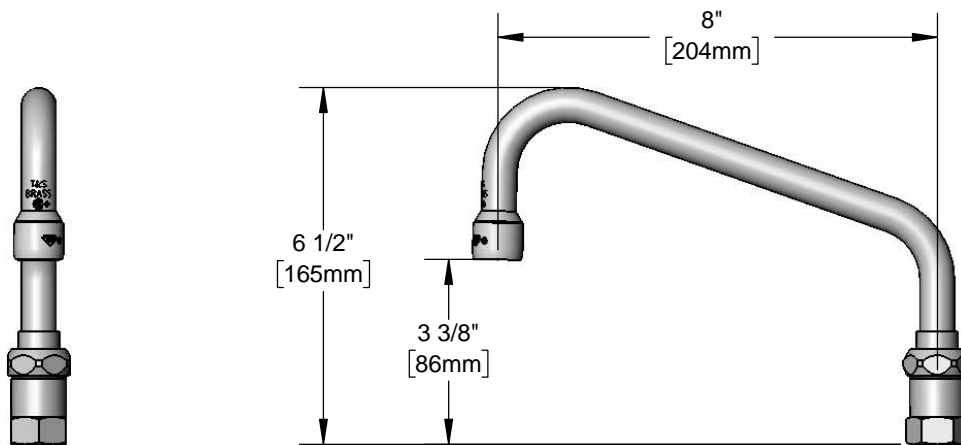
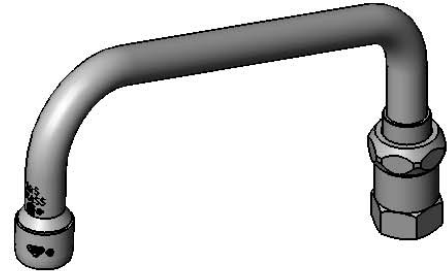

Features & Benefits:

- 8" swing nozzle
- 3/8" NPT female inlet
- Stream regulator outlet, Series 1
- Swivel body
- Material: Chrome plated brass tubular spout

Product Compliance:

- ASME A112.18.1 / CSA B125.1
- NSF 61 - Section 9
- NSF 372 (Low Lead Content)



Warranty: One Year (Limited)



Performance Data:

- Pressure: 20 - 125 psi
- Temperature: 40 °F - 140 °F
- Flow Rate: 26.30 GPM @ 60 psi

